

serie **EUROSTAR 60**

Características

Corredera de corte recto de 60mm.
Dispone de la opción de rueda fija o rueda regulable.
Transmitancia $U_{H,M} = 5,7W/m^2K$.

Sección

Cerco: 60mm.
Hoja: 24mm.
Acrilamiento máximo: 16mm.

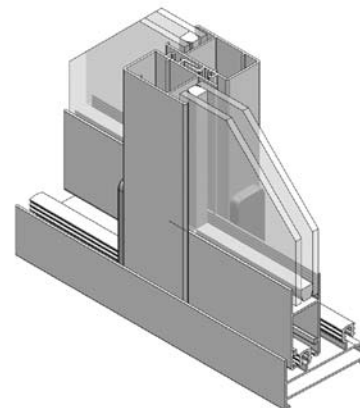

Clasificación del ensayo

VENTANA (1230 x 1480)

| AIRE | AGUA | VIENTO | ACÚSTICO | TÉRMICO |
|----------|-----------|-----------|-----------------|------------------------------------|
| 3 | 3A | C3 | 29 dB | 4,5 W/(m ² K) |

Ventana corredera de 2 hojas y cajón de persiana.
Valores de ensayo con cristal 4/8/4.

BALCONERA (1500 x 2300)

| AIRE | AGUA | VIENTO |
|----------|-----------|-----------|
| 3 | 3A | A1 |

Balconera corredera de 2 hojas y cajón de persiana.
Valores de ensayo con cristal 4/8/4.

Acabados

Anodizado.
Lacado.
Imitación madera mediante sublicromía.
Lacado efecto madera EZY®.



Posibilidades de apertura

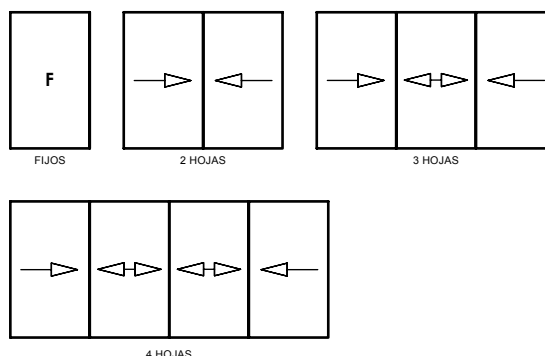

NOTA:

Los perfiles marcados con * es posible que no se encuentren en stock.
Consulta con tu almacén proveedor.
Descárgate el catálogo completo desde nuestra página web: www.grupoayuso.org

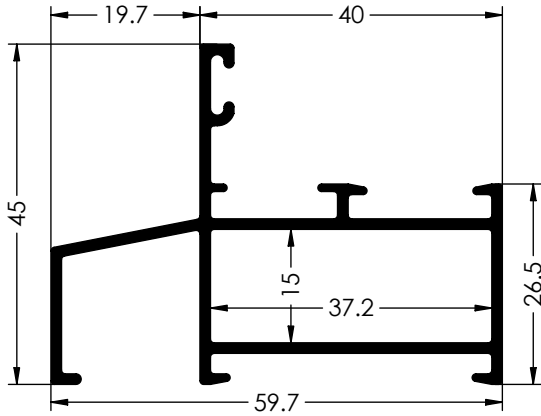

Ref. 6012
CERCOS FIJOS

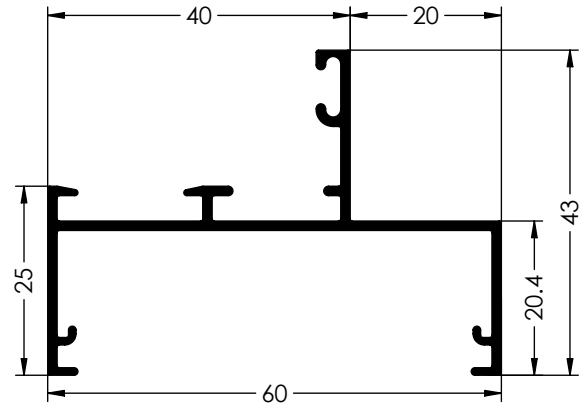

Ref. 6060
CERCOS FIJOS

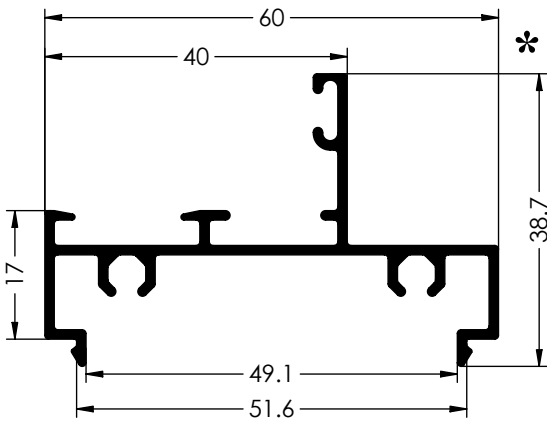

Ref. 6087
CERCOS FIJOS

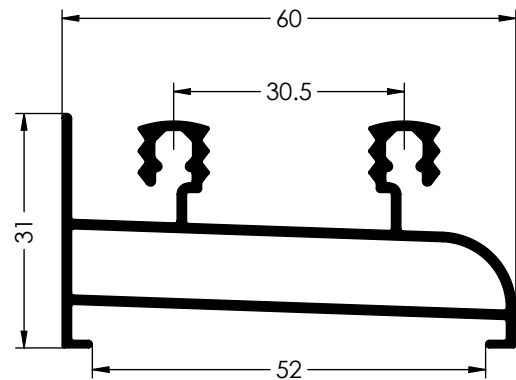

Ref. 6052
CERCOS INFERIORES TUBULARES

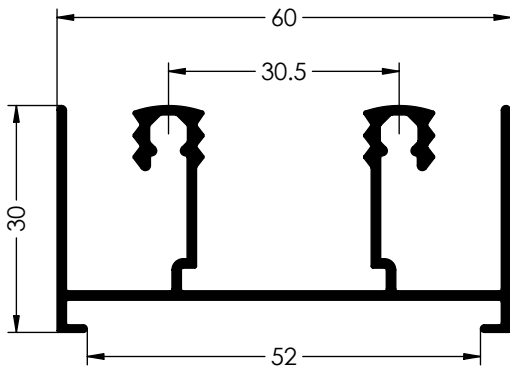

Ref. 6050
CERCOS SUPERIORES

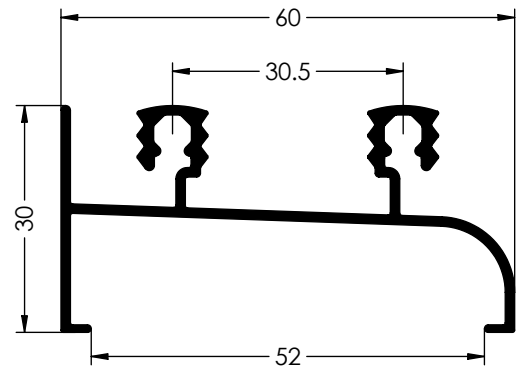

Ref. 6051
CERCOS INFERIORES

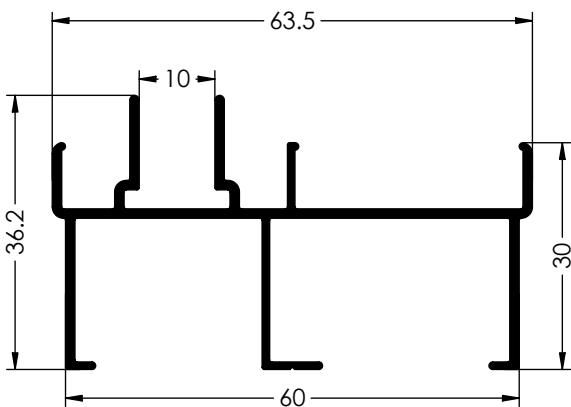

Ref. 6072
CERCOS LATERALES

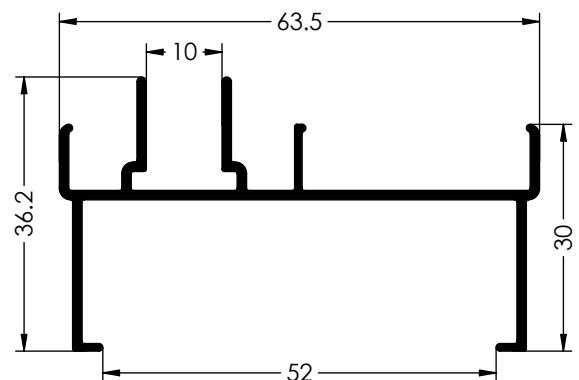

Ref. 6053
CERCOS LATERALES

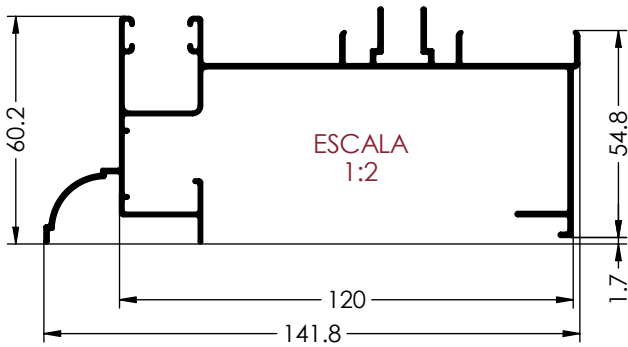

Ref. 6081
CERCOS LATERAL IZQUIERDO (MONOBLOCK)

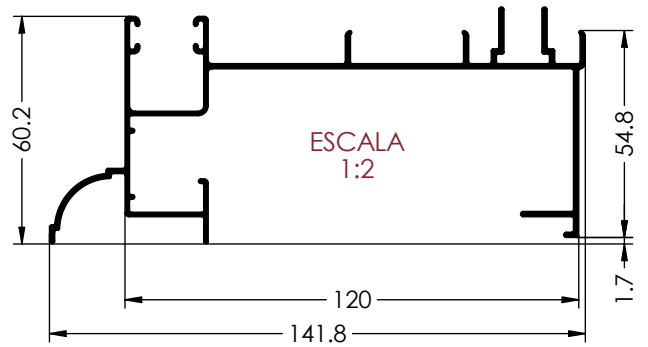

Ref. 6082
CERCOS LATERAL DERECHO (MONOBLOCK)

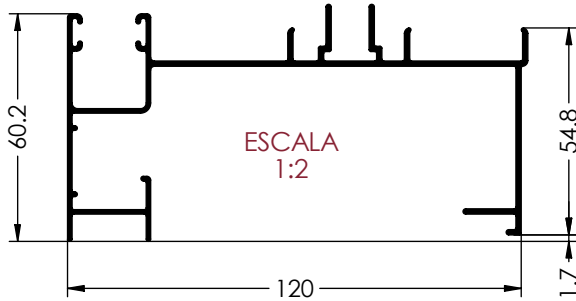

Ref. 6129
CERCOS LATERAL IZQUIERDO (MONOBLOCK)

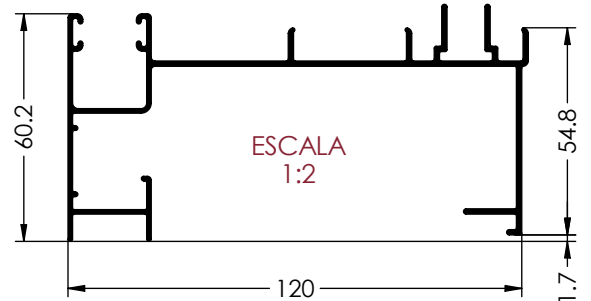

Ref. 6130
CERCOS LATERAL DERECHO (MONOBLOCK)

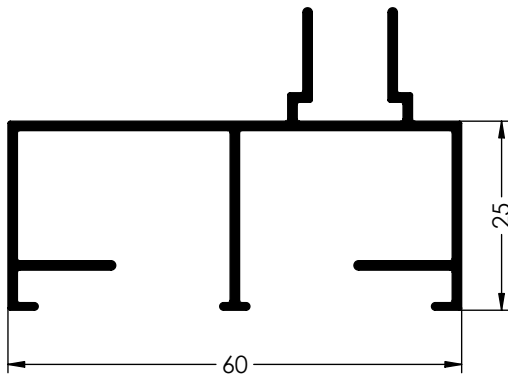

Ref. 6045
CERCOS LATERAL

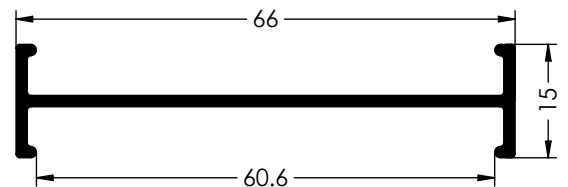

Ref. 3385
UNION MARCOS LATERALES

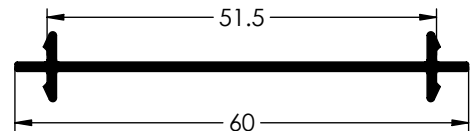

Ref. 6068
UNION CERCOS

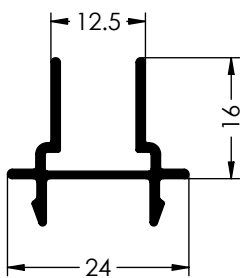

Ref. 6063
COMPLEMENTO 4 HOJAS

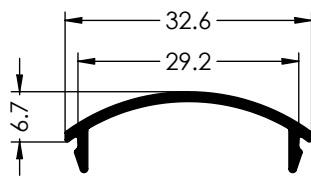

Ref. 6064
EMBELLECEDOR CERCOS LATERAL

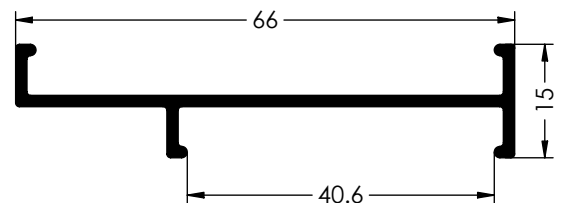

Ref. 3386
UNION CERCOS LATERAL CON PRACTICABLE

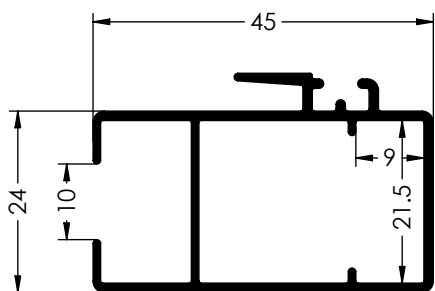

Ref. 6054
HOJA CENTRAL MONOLITICO

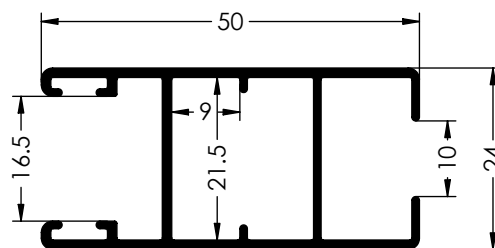

Ref. 6055
HOJA LATERAL MONOLITICO

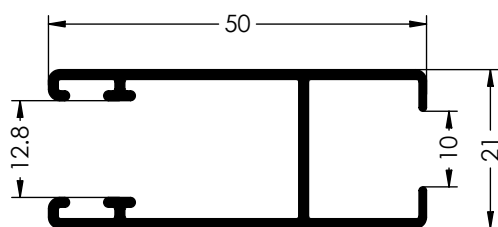

Ref. 6056
HOJA DE RUEDAS MONOLITICO

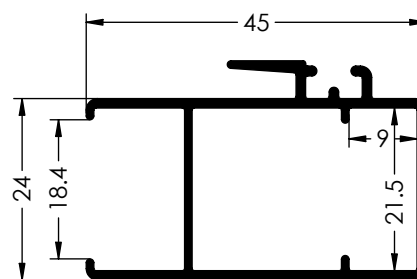

Ref. 6057
HOJA CENTRAL CLIMALIT

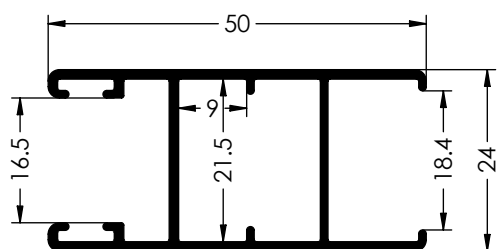

Ref. 6058
HOJA LATERAL CLIMALIT

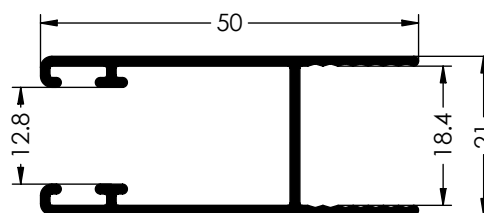

Ref. 6059
HOJA DE RUEDAS CLIMALIT

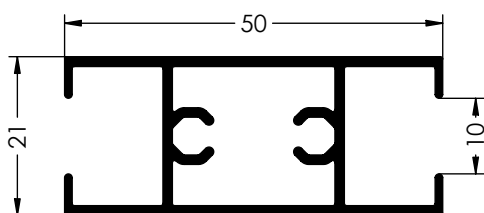

Ref. 6061
PARTELUNAS MONOLITICO

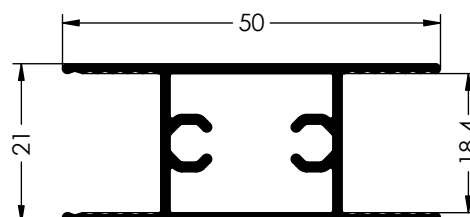

Ref. 6062
PARTELUNAS CLIMALIT

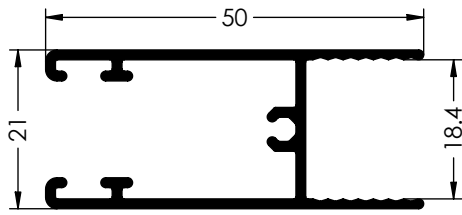

Ref. 6091
HOJA DE RUEDAS GUSANILLO
CLIMALIT

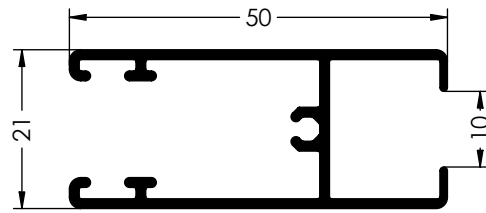

Ref. 6090
HOJA DE RUEDAS GUSANILLO
MONOLITICO

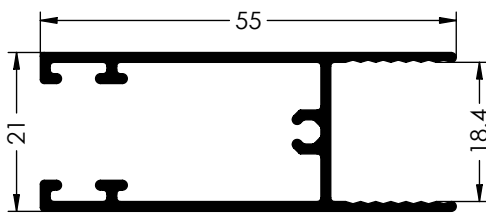

Ref. 6046
HOJA DE RUEDAS GUSANILLO

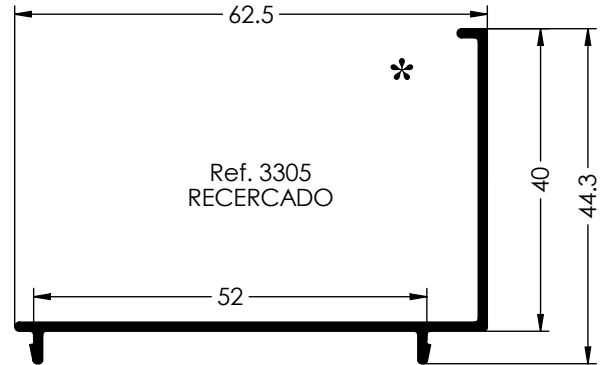

Ref. 3305
RECERCADO



Ref. 6088
ZOCALO RUEDAS MONOLITICO

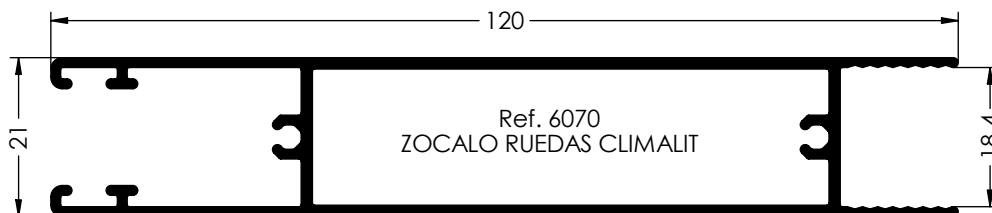

Ref. 6070
ZOCALO RUEDAS CLIMALIT

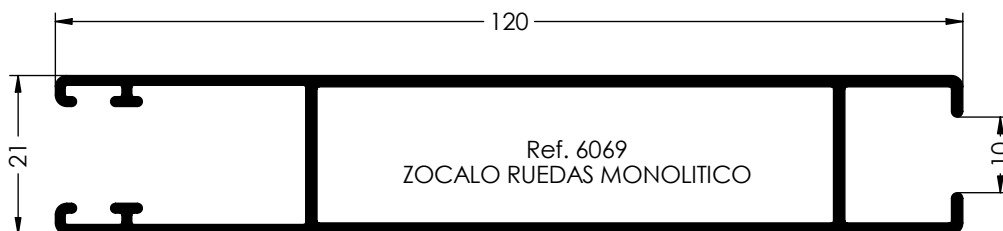

Ref. 6069
ZOCALO RUEDAS MONOLITICO

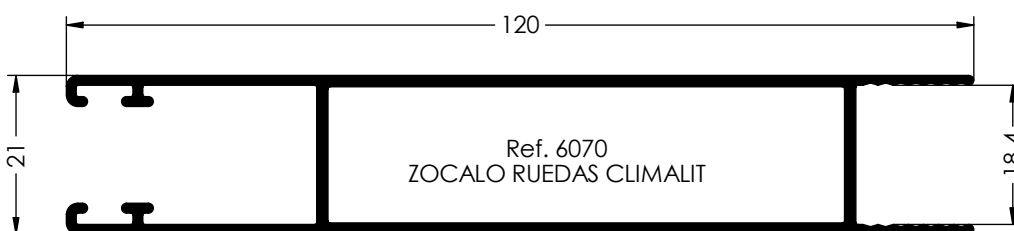

Ref. 6070
ZOCALO RUEDAS CLIMALIT

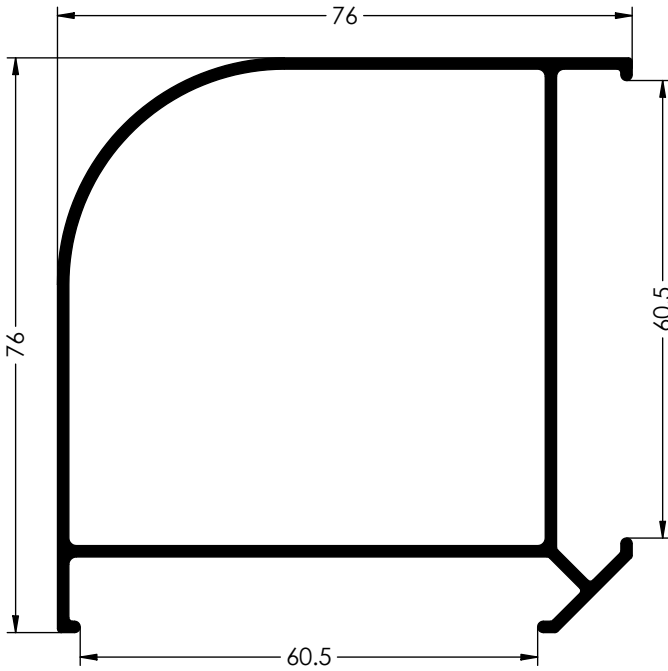

Ref. 3397
ESQUINERO REDONDO

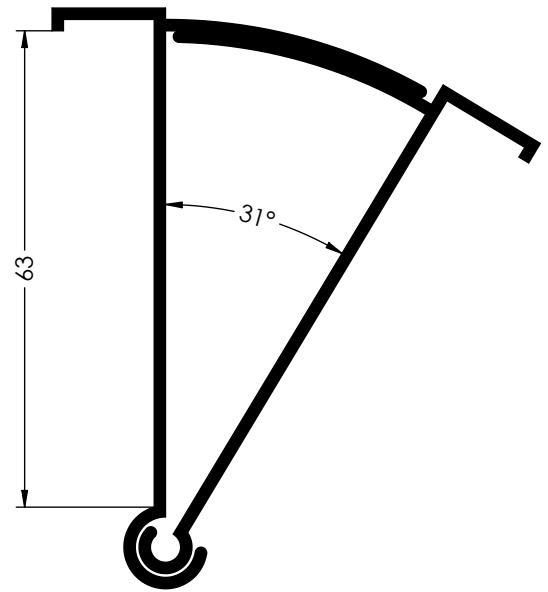

Ref. 3377
ESQUINERO REGULABLE

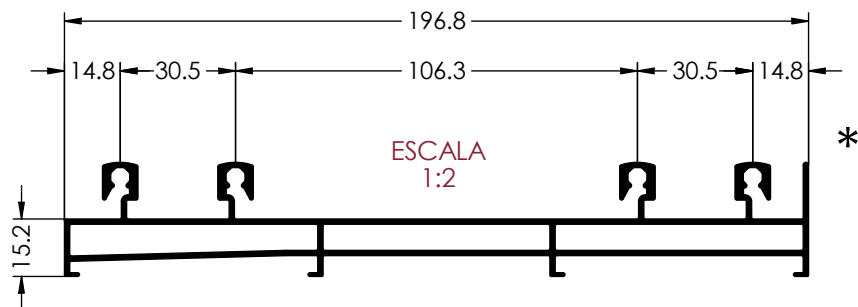

Ref. 6143
CERCO INFERIOR DOBLE

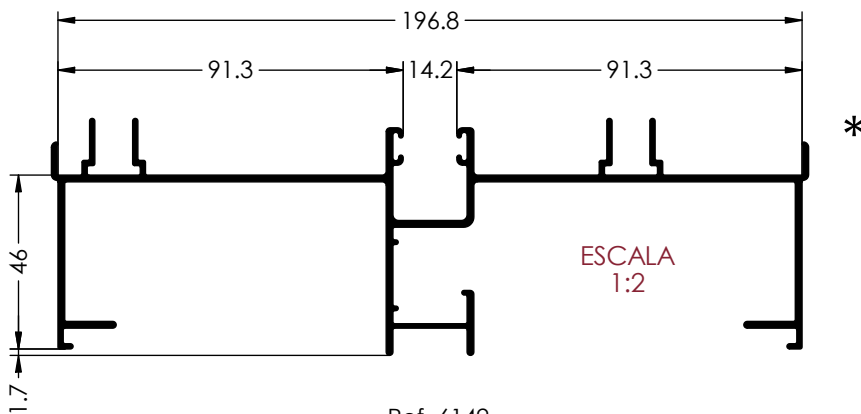

Ref. 6142
CERCO LATERAL DOBLE CON GUÍA

Tabla de acristalamientos

| REF | 1605 | 1720 | 1721* | 1737 | 1688* | 1731 | 1617 | 1633 | 1640* | 1606 | 1696 | 1682* |
|------|------|------|-------|------|-------|------|------|------|-------|------|------|-------|
| 6012 | 9 | 10,4 | 10,4 | 14 | 14 | 14,6 | 19 | 19,5 | 19,5 | 24,5 | 27 | 27 |
| 6060 | 9 | 10,4 | 10,4 | 14 | 14 | 14,6 | 19 | 19,5 | 19,5 | 24,5 | 27 | 27 |
| 6084 | 9 | 10,4 | 10,4 | 14 | 14 | 14,6 | 19 | 19,5 | 19,5 | 24,5 | 27 | 27 |

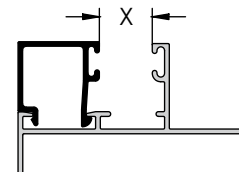

EL RESULTADO ES LA DISTANCIA ENTRE PERFIL Y JUNQUILLO (MILÍMETROS)

* JUNQUILLO CON GRAPA REF.0708

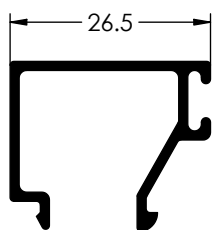

Ref. 1605
JUNQUILLO

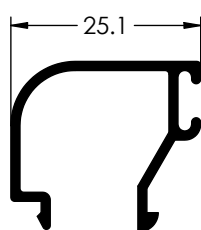

Ref. 1720
JUNQUILLO

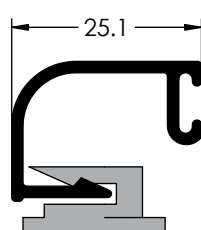

Ref. 1721
JUNQUILLO

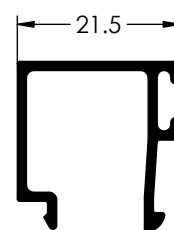

Ref. 1737
JUNQUILLO

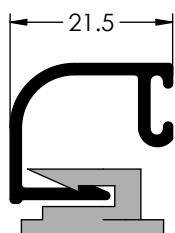

Ref. 1688
JUNQUILLO

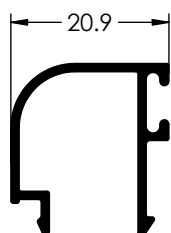

Ref. 1731
JUNQUILLO

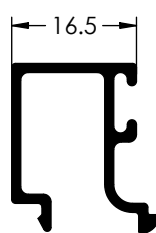

Ref. 1617
JUNQUILLO

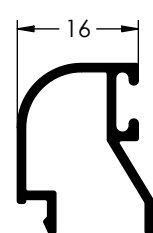

Ref. 1633
JUNQUILLO

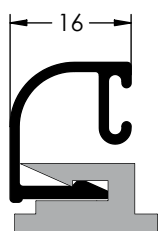

Ref. 1640
JUNQUILLO

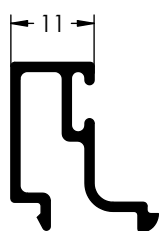

Ref. 1606
JUNQUILLO

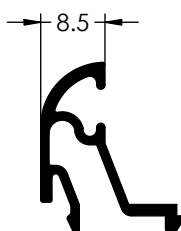

Ref. 1696
JUNQUILLO

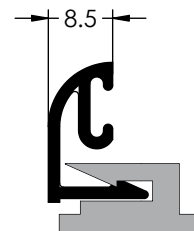

Ref. 1682
JUNQUILLO

| CONJUNTO PLASTICOS STAR 60 - 0553 | | |
|-----------------------------------|---------------------------------|-------|
| REF | DESCRIPCIÓN | UNDS. |
| 0694 | CORTAVIENTO SUPERIOR STAR 60/73 | 1 |
| 0695 | CORTAVIENTOS INFERIOR STAR 60 | 1 |
| 0696 | JUNTAS CERCO INFERIOR STAR 60 | 2 |
| 0747 | TAPETA STAR 60 | 8 |
| 0693 | REMATES EMBELLECEDORES STAR 60 | 4 |
| 0338 | TORNILLOS ROCA CHAPA 5,5X22 | 8 |
| 0340 | TORNILLOS ROCA CHAPA 5,5X38 | 8 |

| CONJUNTO RUEDAS FIJAS STAR 60 - 0554-F | | |
|--|--|-------|
| REF | DESCRIPCIÓN | UNDS. |
| 0691 | CARCASA SUPERIOR FIJA STAR 60 | 4 |
| 0692 | CARCASA INFERIOR RODAMIENTO FIJO STAR 60 | 4 |

| CONJUNTO RUEDAS REGULABLES STAR 60 - 0554-R | | |
|---|---|-------|
| REF | DESCRIPCIÓN | UNDS. |
| 0754 | CARCASA SUPERIOR REGULABLE STAR 60 | 4 |
| 0755 | CARCASA INFERIOR REGULABLE RODAMIENTO STAR 60 | 4 |



Ref.-0111
Cierre pulsador con cerradura

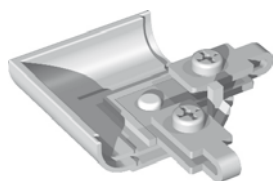

Ref.- 0233
Nudo solape 6085



Ref.- 0281
Embellecedor junquillo serie Euro



Ref.- 0282
Valvula desagüe corredera 100 ud.



Ref.- 0400
Felpudo 7x6 - 100 mtr.



Ref.- 0402
Felpudo 7x7 Film - Seal 100 mtr.

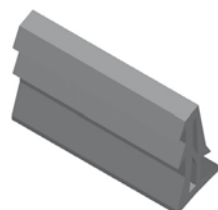

Ref.-0412
Goma cuña grande 100 mtr.

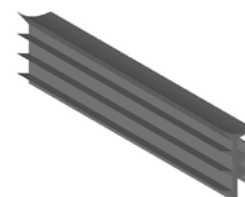

Ref.- 0450
Goma acristalar exterior 100 mtr.

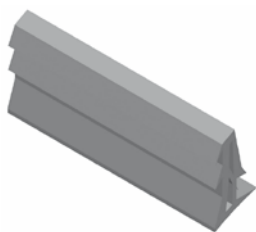

Ref.- 0466
Goma cuña pequeña 100 mtr.



Ref.- 0663
Asa tirador S/ Euro Plus



Ref.- 0690
Cierre

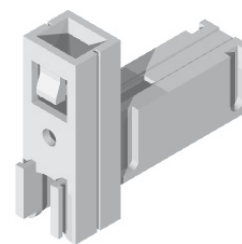

Ref.- 0691
Carcasa Superior Fija



Ref.- 0692
Carcasa Inferior Fija



Ref.- 0693
Remates Embellecedores



Ref.- 0694
Cortavientos Superior



Ref.- 0695
Cortavientos Inferior

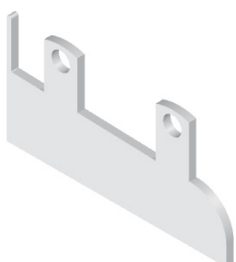

Ref.- 0696
Juntas Cerco Inferior



Ref.- 0697
Rodamiento

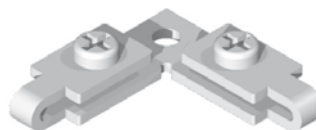

Ref.- 0698
Escuadra solape

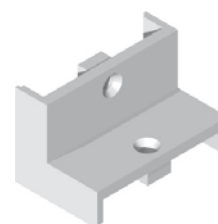

Ref.- 0699
Escuadra Fijos



Ref.- 0708
Grapa Junquillo Redondo (100 UND.)



Ref.- 0747
Tapeta

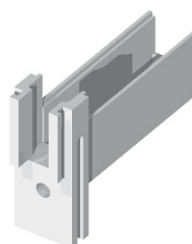

Ref.- 0754
Carcasa Superior Regulable

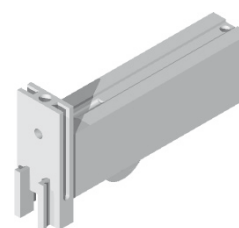

Ref.- 0755
Carcasa Inferior Regulable



Ref.- 1028
Util Star 60



Ref.- 1049
Util Cierre Embutido
Star 60

*



Ref.- 1051
Util Compacto Star 60



Ref.- 1091
Troquel Cierres Star 60-73

Ventana de 2 hojas

SECCIÓN VERTICAL

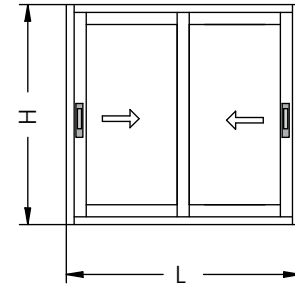
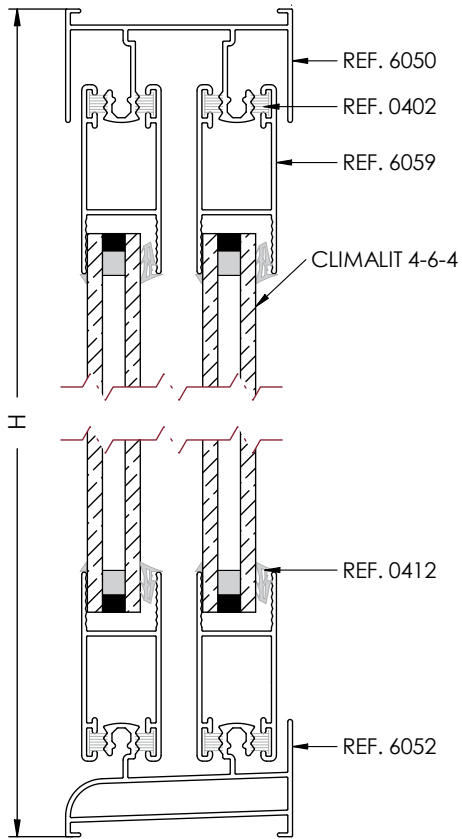

Desglose:

| REF. | DESCRIPCION | UND. | H/V | CORTE | CORTE mm |
|--------|---------------------------|------|--------------------------------|-------|---|
| 6052 | CERCO INFERIOR | 1 | H | 90° | L-43 |
| 6050 | CERCO SUPERIOR | 1 | H | 90° | L-43 |
| 6053 | CERCO LATERAL | 2 | V | 90° | H |
| 6064 | TAPETA CERCO LATERAL | 2 | V | 90° | H-76 |
| 6059 | HOJA DE RUEDAS | 4 | H | 90° | (L-120)/2 ¹ (L-86)/2 ² |
| 6058 | HOJA LATERAL | 2 | V | 90° | H-42 |
| 6057 | HOJA CENTRAL | 2 | V | 90° | H-42 |
| 0402 | FELPUDO FILM -SEAL 7x7mm | 8 | H | 90° | (L-120)/2 ¹ (L-86)/2 ² |
| 0402 | FELPUDO FILM -SEAL 7x7mm | 6 | V | 90° | H-42 |
| 0553 | CONJUNTO PLÁSTICOS | 1 | ELEGIR UNA DE LAS DOS OPCIONES | | |
| 0554-F | CONJUNTO RUEDAS FIJAS | 1 | ELEGIR UNA DE LAS DOS OPCIONES | | |
| 0554-R | CONJUNTO RUEDAS REGULABLE | | | | |

Notas:

- ¹ Carcasa de Ruedas Fija
- ² Carcasa de Ruedas Regulable

Las medidas de este cuadro son orientativas.
El Grupo Ayuso no se hace responsable de posibles errores que se produzcan al utilizar estas medidas.

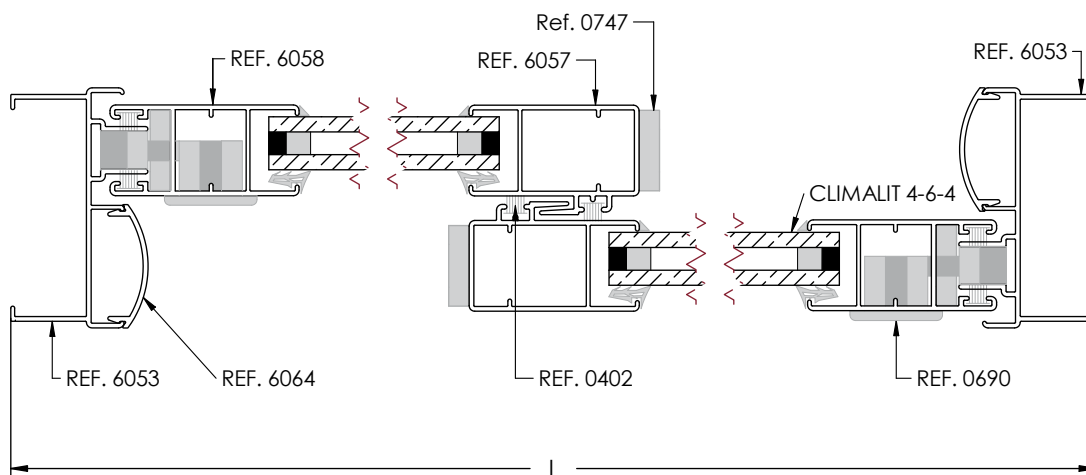

SECCIÓN HORIZONTAL

Ventana de 3 hojas

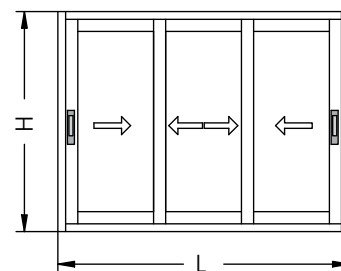

SECCIÓN VERTICAL

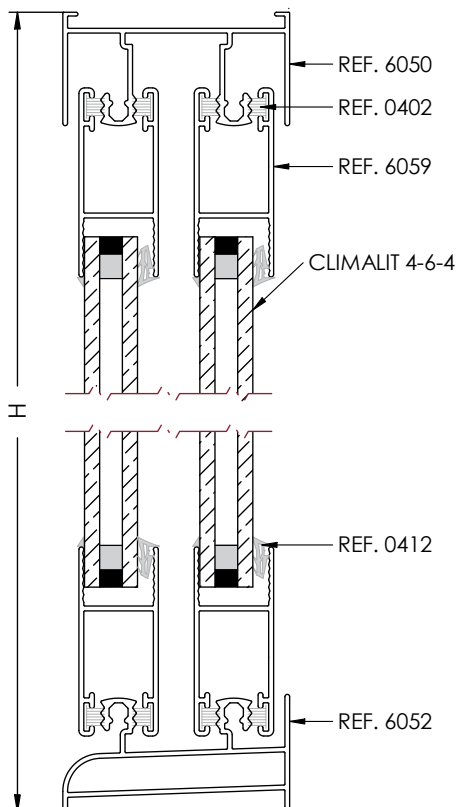

Desglose:

| REF. | DESCRIPCION | UND. | H/V | CORTE | CORTE mm |
|--------|---------------------------|------|--------------------------------|-------|---|
| 6052 | CERCO INFERIOR | 1 | H | 90° | L-43 |
| 6050 | CERCO SUPERIOR | 1 | H | 90° | L-43 |
| 6053 | CERCO LATERAL | 2 | V | 90° | H |
| 6064 | TAPETA CERCO LATERAL | 2 | V | 90° | H-76 |
| 6059 | HOJA DE RUEDAS | 6 | H | 90° | (L-114)/3 ^{*1} (L-64)/3 ^{*2} |
| 6058 | HOJA LATERAL | 2 | V | 90° | H-42 |
| 6057 | HOJA CENTRAL | 4 | V | 90° | H-42 |
| 0402 | FELPUDO FILM-SEAL 7x7mm | 16 | H | 90° | (L-114)/3 ^{*1} (L-64)/3 ^{*2} |
| 0402 | FELPUDO FILM-SEAL 7x7mm | 8 | V | 90° | H-42 |
| 0553 | CONJUNTO PLÁSTICOS | 2 | | | |
| 0554-F | CONJUNTO RUEDAS FIJAS | 2 | ELEGIR UNA DE LAS DOS OPCIONES | | |
| 0554-R | CONJUNTO RUEDAS REGULABLE | | | | |

Notas:

- *1 Carcasa de Ruedas Fija
- *2 Carcasa de Ruedas Regulable

Las medidas de este cuadro son orientativas.
El Grupo Ayuso no se hace responsable de posibles errores que se produzcan al utilizar estas medidas.

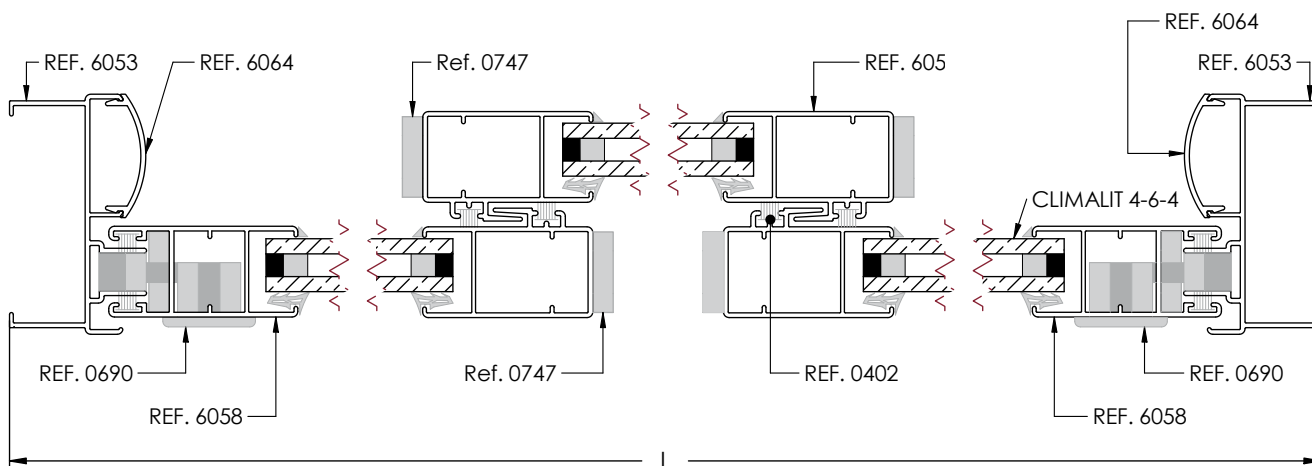

SECCIÓN HORIZONTAL

Ventana de 4 hojas

SECCIÓN VERTICAL

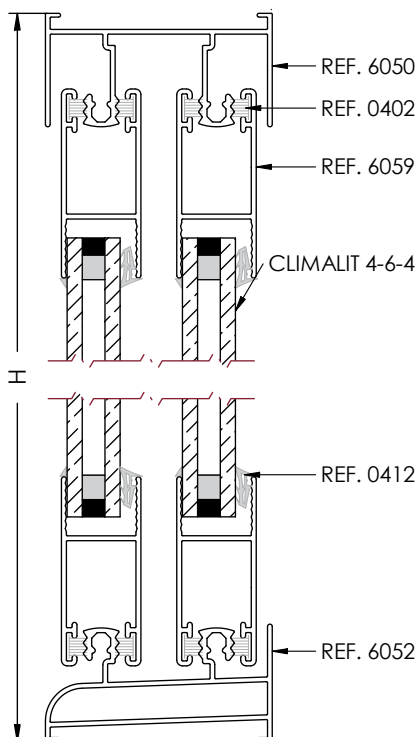
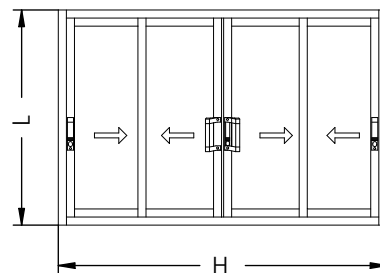

Desglose:

| REF. | DESCRIPCION | UND. | H/V | CORTE | CORTE mm |
|--------|---------------------------|------|--------------------------------|-------|---|
| 6052 | CERCO INFERIOR | 1 | H | 90° | L-43 |
| 6050 | CERCO SUPERIOR | 1 | H | 90° | L-43 |
| 6053 | CERCO LATERAL | 2 | V | 90° | H |
| 6064 | TAPETA CERCO LATERAL | 2 | V | 90° | H-76 |
| 6059 | HOJA DE RUEDAS | 8 | H | 90° | (L-120)/4 ^{*1} (L-70)/4 ^{*2} |
| 6058 | HOJA LATERAL | 4 | V | 90° | H-42 |
| 6057 | HOJA CENTRAL | 4 | V | 90° | H-42 |
| 6063 | COMPLEMENTO 4 HOJAS | 1 | V | 90° | H-42 |
| 0663 | ASA TIRADOR | 2 | | | |
| 0402 | FELPUDO FILM -SEAL 7x7mm | 16 | H | 90° | (L-120)/4 ^{*1} (L-70)/4 ^{*2} |
| 0402 | FELPUDO FILM -SEAL 7x7mm | 10 | V | 90° | H-42 |
| 0553 | CONJUNTO PLÁSTICOS | 2 | | | |
| 0554-F | CONJUNTO RUEDAS FIJAS | 2 | ELEGIR UNA DE LAS DOS OPCIONES | | |
| 0554-R | CONJUNTO RUEDAS REGULABLE | | | | |

Notas:

- *1 Carcasa de Ruedas Fija
- *2 Carcasa de Ruedas Regulable

Las medidas de este cuadro son orientativas.
El Grupo Ayuso no se hace responsable de posibles errores que se produzcan al utilizar estas medidas.

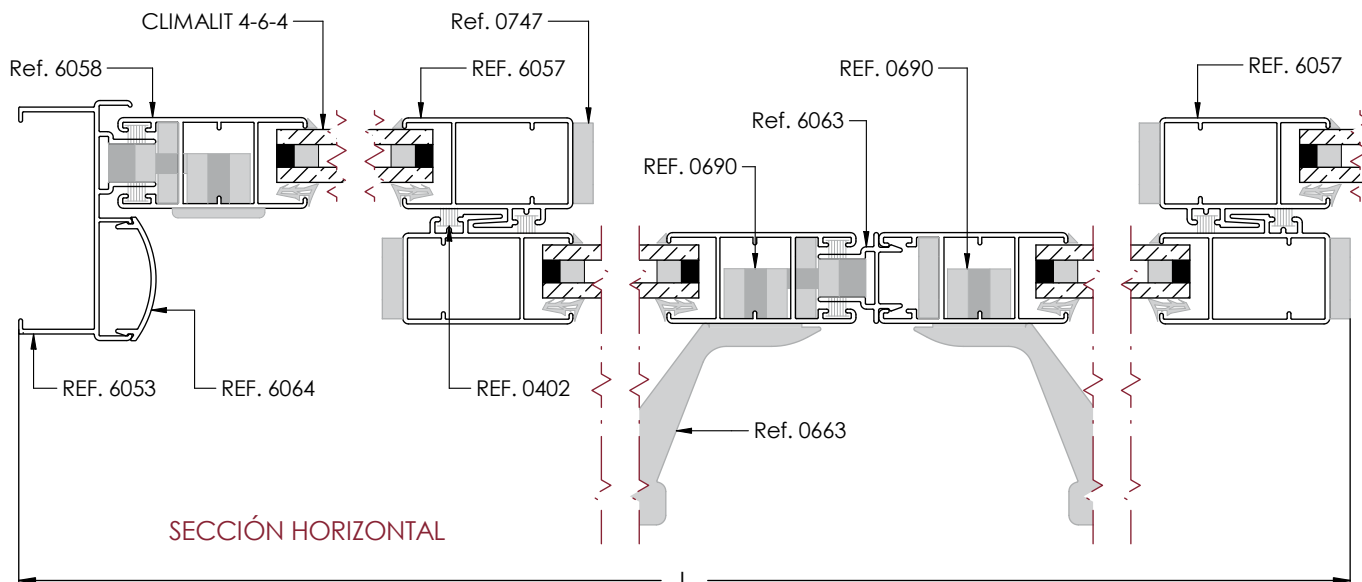

SECCIÓN HORIZONTAL